

FRAISE-A-CHANFREINER-BI-FACE-90°-Z:4-MD-E2-+-EZI-ALPHA-3 · BEVEL-MILLING-CUTTER-BI-FACE-90°-Z:4-CARBIDE-E2-+-EZI-ALPHA-3 · FASENFRAESER-BI-FACE-90°-Z:4-HM-E2-+-EZI-ALPHA-3



SWISS MADE

21735A-3.7

Version vom 07.05.2026

E2

E2 HOCHPRÄZISIONS-WERKSTOFF

$\lambda = 0^\circ$
 $\gamma = 8^\circ$

WERKZEUGWINKEL LAMBDA 0°
GAMMA 8°



BIFACE MEHRPUNKT-SCHNITTSTELLE



SEITLICH SCHNEIDEN DER SPIRALBOHRER

WERKSTOFFKOMPATIBILITÄT

●●● Ausgezeichnet (3/3) ●●○ Gut (2/3) ●○○ Möglich (1/3) ○○○ Nicht empfohlen

WERKSTOFF	SPEZIFIKATION	GRP	21735A-3.7
Legierte und unlegierte Stähle <small>Unlegierte Stähle</small>	Rm < 450 N/mm ²	1a	●●●
	Rm 450–700 N/mm ²	1b	●●●
	Rm 700–900 N/mm ²	1c	●●●
	Rm > 1200 N/mm ²	1d	●●●
Rostfreie Stähle <small>Rostfreie Stähle</small>	Rm < 650 N/mm ²	2a	●●●
	Rm 650–950 N/mm ²	2b	●●●
	Rm > 950 N/mm ²	2c	●●●
Gehärtete Stähle <small>Gehärtete Stähle</small>	44–56 HRC	3a	●●○
	57–67 HRC	3b	●○○
Exotische Werkstoffe <small>Speziallegierungen</small>	< 32 HRC	4a	●●○
	> 32 HRC	4b	●●○
Graphit <small>Industriegraphit</small>		5	●●●
Gusseisen <small>Grau- / Kugelgraphitguss</small>	< 32 HRC	6a	●●●
	> 32 HRC	6b	●●●
Titan <small>Titanlegierungen</small>	Rm < 600 N/mm ²	7a	●●●
	600 < Rm N/mm ²	7b	●●●
Nickellegierungen <small>Inconel, Hastelloy</small>	Rm < 1000 N/mm ²	8a	●●○
	Rm > 1000 N/mm ²	8b	●●○
Kupfer, Messing, Bronze <small>Kupferbasis</small>	Rm < 850 N/mm ²	9a	●●○
	Rm > 850 N/mm ²	9b	●●○
Aluminium <small>Aluminiumlegierungen</small>	Si < 0.5%	10a	●●○
	0.5% < Si < 5%	10b	●●○
	Si > 5%	10c	●●●
Kunststoffe <small>Technische Kunststoffe</small>	Thermoplast	11a	●○○
	Duroplast	11b	●○○
Verbundwerkstoffe <small>Faserverbundwerkstoffe</small>	Glasfaser / GFK	12a	●●●
	Kohlefaser / KFK	12b	●●●
Edelmetalle <small>Gold, Platin, Silber</small>	Gold	13a	●●○
	Platin	13b	●●○

TECHNISCHE ZEICHNUNG

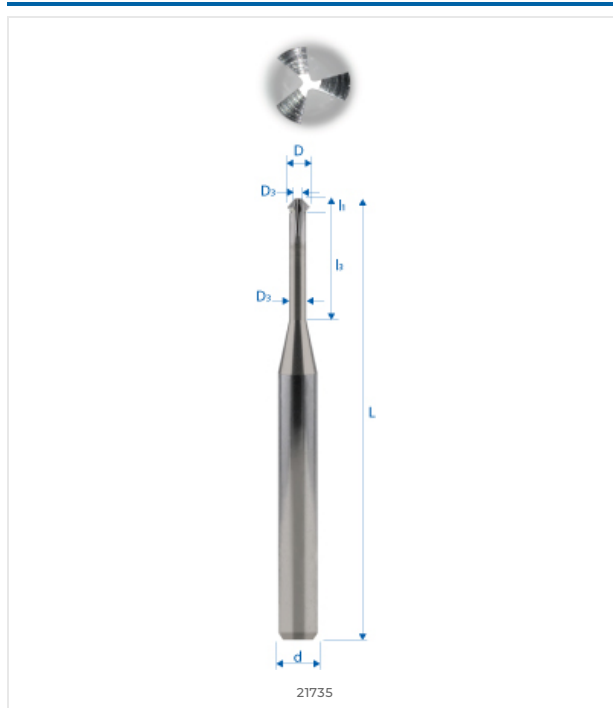

ABMESSUNGEN

NENNMASSE	
D (0 / -0.01)	3.7 mm
d (h5)	4 mm
L	50 mm
l1	0.9 mm
l2	12 mm
d3	–
R	–
e	–
Z	4
Fase K	–
w° collision	0.7°



E-SHOP / EZI CUT
eskenazi.ch/eshop/21735A-3.7

© 2026 Eskenazi SA — Carouge, Genève
Alle Rechte vorbehalten