

FRAISE-PROFIL-ÉBAUCHE-MD-E2-+-EZI-ALPHA,- VERSION-COURTE · ROUGHIN-ENDMILL-SC-E2-+-EZI- ALPHA,-SHORT-VERSION · SCHAFT-SCHRUPPFÄSER- HM-E2-+-EZI-ALPHA,-KURTZE-VERSION



SWISS MADE

22520A-12

Version vom 08.05.2026

E2 E2 HOCHPRÄZISIONS- WERKSTOFF	$\lambda = 30^\circ$ $\gamma = 3^\circ$ SCHNEIDWINKEL $\approx 30^\circ$ $\approx 3^\circ$	45° 45° PRÄZISIONSWINKELMESSUNG	ZWEI-WEGE- SPIRALBOHRER	l_1 1.5xD 1.5XD TIEFE PRÄZISIONSWERKZEUG	KURZE LÄNGE WERKZEUGVERSCHLEISS BALKEN
--	---	--	----------------------------	---	--

WERKSTOFFKOMPATIBILITÄT

●●● Ausgezeichnet (3/3) ●●○ Gut (2/3) ●○○ Möglich (1/3) ○○○ Nicht empfohlen

WERKSTOFF	SPEZIFIKATION	GRP	22520A-12
Legierte und unlegierte Stähle <small>Unlegierte Stähle</small>	Rm < 450 N/mm ²	1a	●●○
	Rm 450–700 N/mm ²	1b	●●○
	Rm 700–900 N/mm ²	1c	●●○
	Rm > 1200 N/mm ²	1d	●○○
Rostfreie Stähle <small>Rostfreie Stähle</small>	Rm < 650 N/mm ²	2a	●●○
	Rm 650–950 N/mm ²	2b	●●○
	Rm > 950 N/mm ²	2c	●●○
Gehärtete Stähle <small>Gehärtete Stähle</small>	44–56 HRC	3a	○○○
	57–67 HRC	3b	○○○
Exotische Werkstoffe <small>Speziallegierungen</small>	< 32 HRC	4a	●○○
	> 32 HRC	4b	●○○
Graphit <small>Industriegraphit</small>		5	○○○
Gusseisen <small>Grau- / Kugelgraphitguss</small>	< 32 HRC	6a	●●●
	> 32 HRC	6b	●●●
Titan <small>Titanlegierungen</small>	Rm < 600 N/mm ²	7a	●●○
	600 < Rm N/mm ²	7b	●○○
Nickellegierungen <small>Inconel, Hastelloy</small>	Rm < 1000 N/mm ²	8a	●○○
	Rm > 1000 N/mm ²	8b	●○○
Kupfer, Messing, Bronze <small>Kupferbasis</small>	Rm < 850 N/mm ²	9a	●●○
	Rm > 850 N/mm ²	9b	●●○
Aluminium <small>Aluminiumlegierungen</small>	Si < 0.5%	10a	○○○
	0.5% < Si < 5%	10b	○○○
	Si > 5%	10c	○○○
Kunststoffe <small>Technische Kunststoffe</small>	Thermoplast	11a	○○○
	Duroplast	11b	○○○
Verbundwerkstoffe <small>Faserverbundwerkstoffe</small>	Glasfaser / GFK	12a	○○○
	Kohlefaser / KFK	12b	○○○
Edelmetalle <small>Gold, Platin, Silber</small>	Gold	13a	●●○
	Platin	13b	●○○

TECHNISCHE ZEICHNUNG

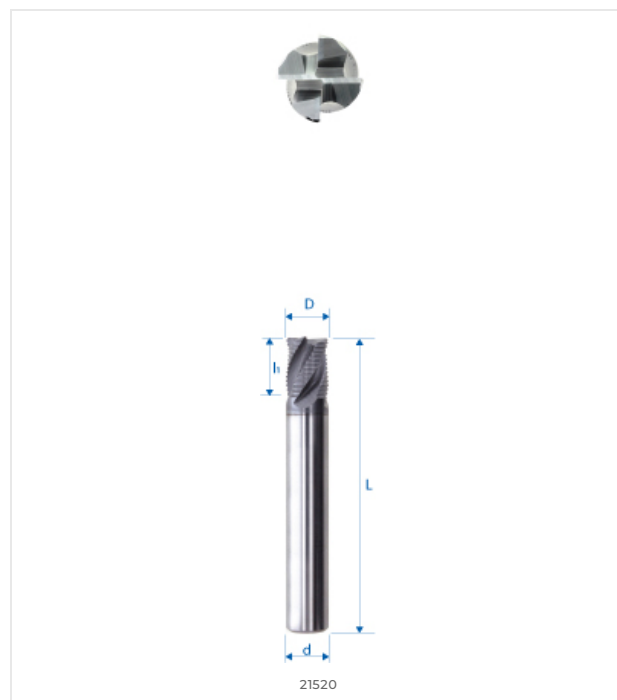

ABMESSUNGEN

NENNMASSE	
D (0 / -0.01)	12 mm
d (h5)	12 mm
L	73 mm
l1	12 mm
l3	–
d3	–
R	–
e	–
Z	4
Fase K	0.4
w° collision	–



E-SHOP / EZI CUT
eskenazi.ch/eshop/22520A-12