

# FRAISE-PROFIL-ÉBAUCHE-MD-E2-+-EZI-ALPHA,- VERSION-COURTE · ROUGHIN-ENDMILL-SC-E2-+-EZI- ALPHA,-SHORT-VERSION · SCHAFT-SCHRUPPFÄSER- HM-E2-+-EZI-ALPHA,-KURTZE-VERSION



SWISS MADE

22520A-5-6

Version vom 08.05.2026

<b>E2</b> E2 HOCHPRÄZISIONS- WERKSTOFF	$\lambda = 30^\circ$ $\gamma = 3^\circ$ SCHNEIDWINKEL $\approx 30^\circ$ $\approx 3^\circ$	$45^\circ$ 45° PRÄZISIONSWINKELMESSUNG	ZWEI-WEGE- SPIRALBOHRER	$l_1$ 1.5xD 1.5XD TIEFE PRÄZISIONSWERKZEUG	KURZE LÄNGE WERKZEUGVERSCHLEISS BALKEN
--	---	--	----------------------------	---	--

## WERKSTOFFKOMPATIBILITÄT

●●● Ausgezeichnet (3/3) ●●○ Gut (2/3) ●○○ Möglich (1/3) ○○○ Nicht empfohlen

WERKSTOFF	SPEZIFIKATION	GRP	22520A-5-6
<b>Legierte und unlegierte Stähle</b> <small>Unlegierte Stähle</small>	Rm < 450 N/mm <sup>2</sup>	1a	●●○
	Rm 450–700 N/mm <sup>2</sup>	1b	●●○
	Rm 700–900 N/mm <sup>2</sup>	1c	●●○
	Rm > 1200 N/mm <sup>2</sup>	1d	●○○
<b>Rostfreie Stähle</b> <small>Rostfreie Stähle</small>	Rm < 650 N/mm <sup>2</sup>	2a	●●○
	Rm 650–950 N/mm <sup>2</sup>	2b	●●○
	Rm > 950 N/mm <sup>2</sup>	2c	●●○
<b>Gehärtete Stähle</b> <small>Gehärtete Stähle</small>	44–56 HRC	3a	○○○
	57–67 HRC	3b	○○○
<b>Exotische Werkstoffe</b> <small>Speziallegierungen</small>	< 32 HRC	4a	●○○
	> 32 HRC	4b	●○○
<b>Graphit</b> <small>Industriegraphit</small>		5	○○○
<b>Gusseisen</b> <small>Grau- / Kugelgraphitguss</small>	< 32 HRC	6a	●●●
	> 32 HRC	6b	●●●
<b>Titan</b> <small>Titanlegierungen</small>	Rm < 600 N/mm <sup>2</sup>	7a	●●○
	600 < Rm N/mm <sup>2</sup>	7b	●○○
<b>Nickellegierungen</b> <small>Inconel, Hastelloy</small>	Rm < 1000 N/mm <sup>2</sup>	8a	●○○
	Rm > 1000 N/mm <sup>2</sup>	8b	●○○
<b>Kupfer, Messing, Bronze</b> <small>Kupferbasis</small>	Rm < 850 N/mm <sup>2</sup>	9a	●●○
	Rm > 850 N/mm <sup>2</sup>	9b	●●○
<b>Aluminium</b> <small>Aluminiumlegierungen</small>	Si < 0.5%	10a	○○○
	0.5% < Si < 5%	10b	○○○
	Si > 5%	10c	○○○
<b>Kunststoffe</b> <small>Technische Kunststoffe</small>	Thermoplast	11a	○○○
	Duroplast	11b	○○○
<b>Verbundwerkstoffe</b> <small>Faserverbundwerkstoffe</small>	Glasfaser / GFK	12a	○○○
	Kohlefaser / KFK	12b	○○○
<b>Edelmetalle</b> <small>Gold, Platin, Silber</small>	Gold	13a	●●○
	Platin	13b	●○○

## TECHNISCHE ZEICHNUNG

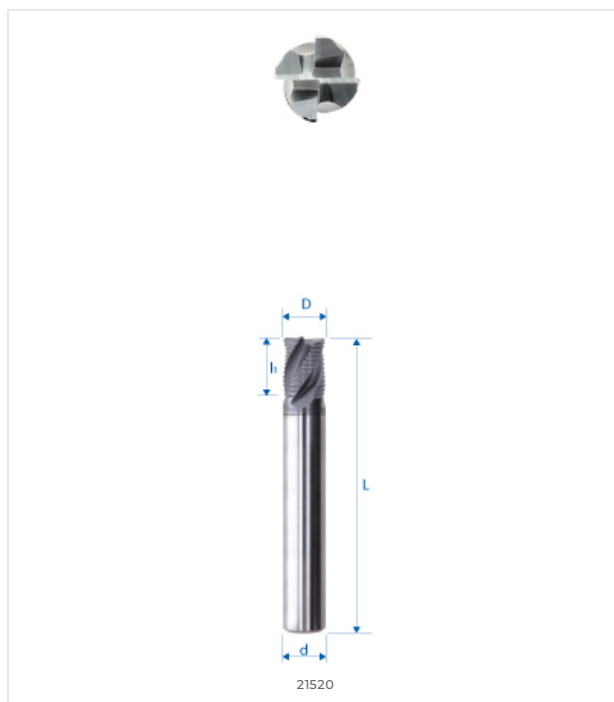

## ABMESSUNGEN

NENNMASSE	
D (0 / -0.01)	5 mm
d (h5)	6 mm
L	50 mm
l1	6 mm
l3	–
d3	–
R	–
e	–
Z	3
Fase K	0.3
w° collision	3.7°



E-SHOP / EZI CUT  
[eskenazi.ch/eshop/22520A-5-6](https://eskenazi.ch/eshop/22520A-5-6)