

ALÉSOIR-MD-E2S-+-TROU-D'ARROSAGE · -REAMER-SC-E2S-+-INTERNAL-COOLING · REIBAHLEN-HM-E2S-+-COOLING



SWISS MADE

47480S-2.98

Version vom 07.05.2026

E2

E2 HOCHPRÄZISIONS-WERKSTOFF

$\lambda = -5^\circ$
 $\gamma = 5^\circ$

SCHNEIDWINKEL ? -5° ? 5°



ZENTRALKÜHLUNG BOHRER

WERKSTOFFKOMPATIBILITÄT

●●● Ausgezeichnet (3/3) ●●○ Gut (2/3) ●○○ Möglich (1/3) ○○○ Nicht empfohlen

WERKSTOFF	SPEZIFIKATION	GRP	47480S-2.98
Legierte und unlegierte Stähle Unlegierte Stähle	Rm < 450 N/mm ²	1a	●●●
	Rm 450–700 N/mm ²	1b	●●●
	Rm 700–900 N/mm ²	1c	●●●
	Rm > 1200 N/mm ²	1d	●●●
Rostfreie Stähle Rostfreie Stähle	Rm < 650 N/mm ²	2a	●●●
	Rm 650–950 N/mm ²	2b	●●●
	Rm > 950 N/mm ²	2c	●●●
Gehärtete Stähle Gehärtete Stähle	44–56 HRC	3a	●●○
	57–67 HRC	3b	●●○
Exotische Werkstoffe Speziallegierungen	< 32 HRC	4a	●●●
	> 32 HRC	4b	●●●
Graphit Industriegraphit		5	●●●
Gusseisen Grau- / Kugelgraphitguss	< 32 HRC	6a	●●●
	> 32 HRC	6b	●●●
Titan Titanlegierungen	Rm < 600 N/mm ²	7a	●●●
	600 < Rm N/mm ²	7b	●●●
Nickellegierungen Inconel, Hastelloy	Rm < 1000 N/mm ²	8a	●●●
	Rm > 1000 N/mm ²	8b	●●●
Kupfer, Messing, Bronze Kupferbasis	Rm < 850 N/mm ²	9a	●●●
	Rm > 850 N/mm ²	9b	●●●
Aluminium Aluminiumlegierungen	Si < 0.5%	10a	●●●
	0.5% < Si < 5%	10b	●●●
	Si > 5%	10c	●●●
Kunststoffe Technische Kunststoffe	Thermoplast	11a	●●●
	Duroplast	11b	●●●
Verbundwerkstoffe Faserverbundwerkstoffe	Glasfaser / GFK	12a	●●●
	Kohlefaser / KFK	12b	●●●
Edelmetalle Gold, Platin, Silber	Gold	13a	●●●
	Platin	13b	●●○

TECHNISCHE ZEICHNUNG

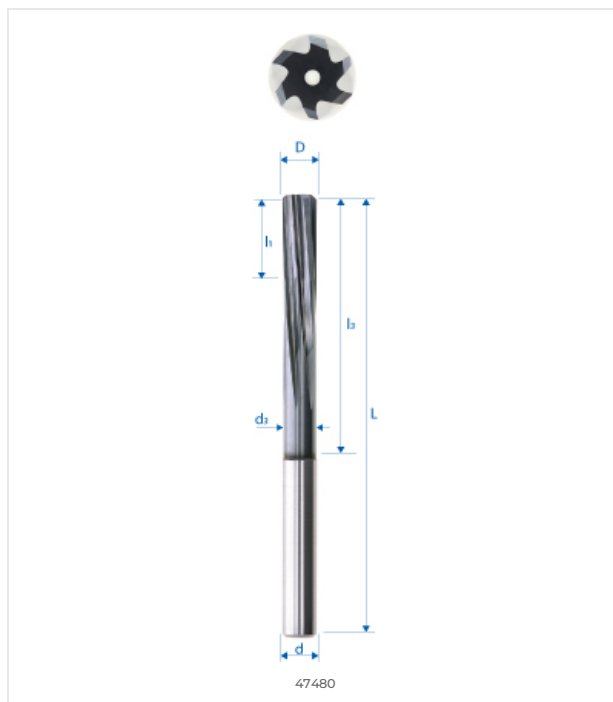

ABMESSUNGEN

NENNMASSE	
D (0 / -0.01)	2.98 mm
d (h5)	3 mm
L	60 mm
l1	15 mm
l3	30 mm
d3	–
R	–
e	–
Z	4
Fase K	0.3
w° collision	–



E-SHOP / EZI CUT
eskenazi.ch/eshop/47480S-2.98

© 2026 Eskenazi SA — Carouge, Genève
Alle Rechte vorbehalten