

# RONDELLE-MD-HIS-BRUT-DE-FRITTAGE · SAW-BLANKS-SC-HIS-JUST-SINTERED · RONDEN-HM-HIS-ROH-GESINTERT



SWISS MADE

20150-25-8-2.8

Version 07.05.2026

25.5  
Ø D (MM)

## MATERIAL COMPATIBILITY

●●● Excellent (3/3) ●● Good (2/3) ●○ Possible (1/3) ○○○ Not recommended

MATERIAL	SPECIFICATION	GRP	20150-25-8-2.8
<b>Alloyed and non-alloyed steels</b> <small>Non-alloyed steels</small>	Rm < 450 N/mm <sup>2</sup>	1a	○○○
	Rm 450–700 N/mm <sup>2</sup>	1b	○○○
	Rm 700–900 N/mm <sup>2</sup>	1c	○○○
	Rm > 1200 N/mm <sup>2</sup>	1d	○○○
<b>Stainless steels</b> <small>Stainless steels</small>	Rm < 650 N/mm <sup>2</sup>	2a	○○○
	Rm 650–950 N/mm <sup>2</sup>	2b	○○○
	Rm > 950 N/mm <sup>2</sup>	2c	○○○
<b>Hardened steels</b> <small>Hardened steels</small>	44–56 HRC	3a	○○○
	57–67 HRC	3b	○○○
<b>Exotic materials</b> <small>Special alloys</small>	< 32 HRC	4a	○○○
	> 32 HRC	4b	○○○
<b>Graphite</b> <small>Industrial graphite</small>		5	○○○
<b>Cast iron</b> <small>Grey / nodular cast iron</small>	< 32 HRC	6a	○○○
	> 32 HRC	6b	○○○
<b>Titanium</b> <small>Titanium alloys</small>	Rm < 600 N/mm <sup>2</sup>	7a	○○○
	600 < Rm N/mm <sup>2</sup>	7b	○○○
<b>Nickel alloys</b> <small>Inconel, Hastelloy</small>	Rm < 1000 N/mm <sup>2</sup>	8a	○○○
	Rm > 1000 N/mm <sup>2</sup>	8b	○○○
<b>Copper, brass, bronze</b> <small>Copper-based</small>	Rm < 850 N/mm <sup>2</sup>	9a	○○○
	Rm > 850 N/mm <sup>2</sup>	9b	○○○
<b>Aluminum</b> <small>Aluminum alloys</small>	Si < 0.5%	10a	○○○
	0.5% < Si < 5%	10b	○○○
	Si > 5%	10c	○○○
<b>Synthetic materials</b> <small>Engineering plastics</small>	Thermoplastic	11a	○○○
	Thermoset	11b	○○○
<b>Composite materials</b> <small>Reinforced composites</small>	Glass fiber / GFK	12a	○○○
	Carbon fiber / KFK	12b	○○○
<b>Precious metals</b> <small>Gold, platinum, silver</small>	Gold	13a	○○○
	Platinum	13b	○○○

## TECHNICAL DRAWING

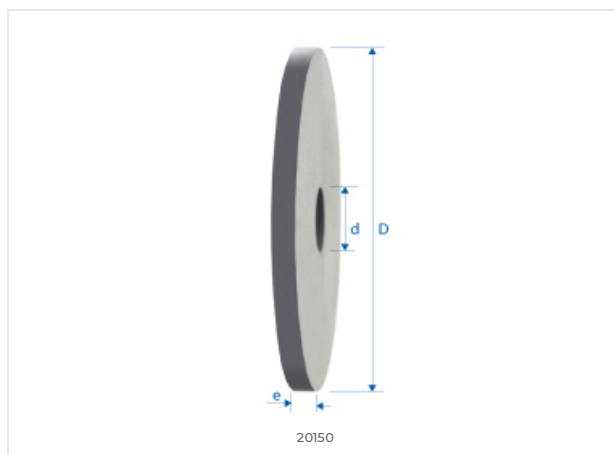

## DIMENSIONS

NOMINAL DIMENSIONS	
D (0 / -0.01)	25.5 mm
d (h5)	7.7 mm
L	-
l1	-
l3	-
d3	-
R	-
e	2.8 mm
Z	-
Chamfer K	-
w° collision	-



E-SHOP / EZI CUT  
eskenazi.ch/eshop/20150-25-8-2.8

© 2026 Eskenazi SA — Carouge, Genève  
All rights reserved