

RONDELLE-MD-HIS-BRUT-DE-FRITTAGE · SAW-BLANKS-SC-HIS-JUST-SINTERED · RONDEN-HM-HIS-ROH-GESINTERT



SWISS MADE

20150-45-10-0.8

Version 07.05.2026

45.5
Ø D (MM)

MATERIAL COMPATIBILITY

●●● Excellent (3/3) ●● Good (2/3) ●○ Possible (1/3) ○○○ Not recommended

MATERIAL	SPECIFICATION	GRP	20150-45-10-0.8
Alloyed and non-alloyed steels <small>Non-alloyed steels</small>	Rm < 450 N/mm ²	1a	○○○
	Rm 450–700 N/mm ²	1b	○○○
	Rm 700–900 N/mm ²	1c	○○○
	Rm > 1200 N/mm ²	1d	○○○
Stainless steels <small>Stainless steels</small>	Rm < 650 N/mm ²	2a	○○○
	Rm 650–950 N/mm ²	2b	○○○
	Rm > 950 N/mm ²	2c	○○○
Hardened steels <small>Hardened steels</small>	44–56 HRC	3a	○○○
	57–67 HRC	3b	○○○
Exotic materials <small>Special alloys</small>	< 32 HRC	4a	○○○
	> 32 HRC	4b	○○○
Graphite <small>Industrial graphite</small>		5	○○○
Cast iron <small>Grey / nodular cast iron</small>	< 32 HRC	6a	○○○
	> 32 HRC	6b	○○○
Titanium <small>Titanium alloys</small>	Rm < 600 N/mm ²	7a	○○○
	600 < Rm N/mm ²	7b	○○○
Nickel alloys <small>Inconel, Hastelloy</small>	Rm < 1000 N/mm ²	8a	○○○
	Rm > 1000 N/mm ²	8b	○○○
Copper, brass, bronze <small>Copper-based</small>	Rm < 850 N/mm ²	9a	○○○
	Rm > 850 N/mm ²	9b	○○○
Aluminum <small>Aluminum alloys</small>	Si < 0.5%	10a	○○○
	0.5% < Si < 5%	10b	○○○
	Si > 5%	10c	○○○
Synthetic materials <small>Engineering plastics</small>	Thermoplastic	11a	○○○
	Thermoset	11b	○○○
Composite materials <small>Reinforced composites</small>	Glass fiber / GFK	12a	○○○
	Carbon fiber / KFK	12b	○○○
Precious metals <small>Gold, platinum, silver</small>	Gold	13a	○○○
	Platinum	13b	○○○

TECHNICAL DRAWING

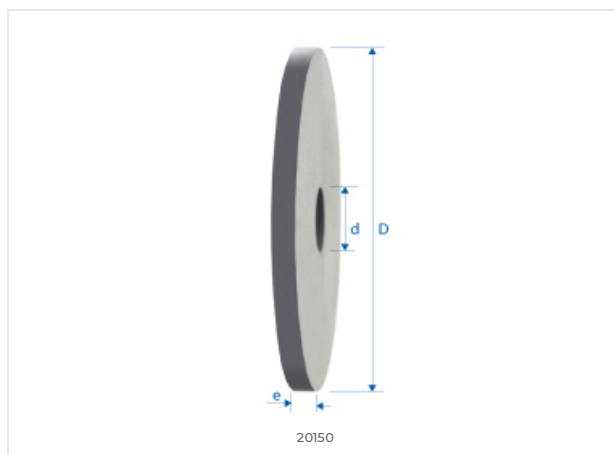

DIMENSIONS

NOMINAL DIMENSIONS	
D (0 / -0.01)	45.5 mm
d (h5)	9.7 mm
L	–
l1	–
l3	–
d3	–
R	–
e	0.8 mm
Z	–
Chamfer K	–
w° collision	–



E-SHOP / EZI CUT
eskenazi.ch/eshop/20150-45-10-0.8

© 2026 Eskenazi SA — Carouge, Genève
All rights reserved