

MICRO-FRAISE-HÉMISPHERIQUE Z2 · BALL-NOSE- MICRO-ENDMILL Z2 · MICRO-FRÄSER-HALBRUND Z2



21093A-0.5

Version 07.05.2026

SWISS MADE

<p>E25 UF</p> <p>CARBIDE TOOL MATERIAL E25 UF</p>	<p>$\lambda = 30^\circ$ $\gamma = 10^\circ$</p> <p>CUTTING ANGLES ? 30° ?10°</p>	<p>V-GROOVE CHAMFER TOOL SHAPE</p>	<p>DUAL DIRECTION HELICAL DRILL BIT</p>	<p>1.5xD</p> <p>1.5xD DEPTH PRECISION TOOL</p>	<p>L3 8xD</p> <p>8xD LENGTH L3 CUTTING TOOL</p>	<p>STANDARD TOOL WEAR INDICATOR</p>
---	--	--	---	--	---	---

MATERIAL COMPATIBILITY

●●● Excellent (3/3) ●●○ Good (2/3) ●○○ Possible (1/3) ○○○ Not recommended

MATERIAL	SPECIFICATION	GRP	21093A-0.5
Alloyed and non-alloyed steels <small>Non-alloyed steels</small>	Rm < 450 N/mm ²	1a	●●●
	Rm 450–700 N/mm ²	1b	●●●
	Rm 700–900 N/mm ²	1c	●●●
	Rm > 1200 N/mm ²	1d	●●●
Stainless steels <small>Stainless steels</small>	Rm < 650 N/mm ²	2a	●●●
	Rm 650–950 N/mm ²	2b	●●●
	Rm > 950 N/mm ²	2c	●●●
Hardened steels <small>Hardened steels</small>	44–56 HRC	3a	●●○
	57–67 HRC	3b	●○○
Exotic materials <small>Special alloys</small>	< 32 HRC	4a	●●○
	> 32 HRC	4b	●○○
Graphite <small>Industrial graphite</small>		5	●●○
Cast iron <small>Grey / nodular cast iron</small>	< 32 HRC	6a	●●○
	> 32 HRC	6b	●●○
Titanium <small>Titanium alloys</small>	Rm < 600 N/mm ²	7a	●●●
	600 < Rm N/mm ²	7b	●●●
Nickel alloys <small>Inconel, Hastelloy</small>	Rm < 1000 N/mm ²	8a	●●○
	Rm > 1000 N/mm ²	8b	●●○
Copper, brass, bronze <small>Copper-based</small>	Rm < 850 N/mm ²	9a	●○○
	Rm > 850 N/mm ²	9b	●○○
Aluminum <small>Aluminum alloys</small>	Si < 0.5%	10a	●○○
	0.5% < Si < 5%	10b	●○○
	Si > 5%	10c	●○○
Synthetic materials <small>Engineering plastics</small>	Thermoplastic	11a	○○○
	Thermoset	11b	○○○
Composite materials <small>Reinforced composites</small>	Glass fiber / GFK	12a	●●○
	Carbon fiber / KFK	12b	●●○
Precious metals <small>Gold, platinum, silver</small>	Gold	13a	●●○
	Platinum	13b	●○○

TECHNICAL DRAWING

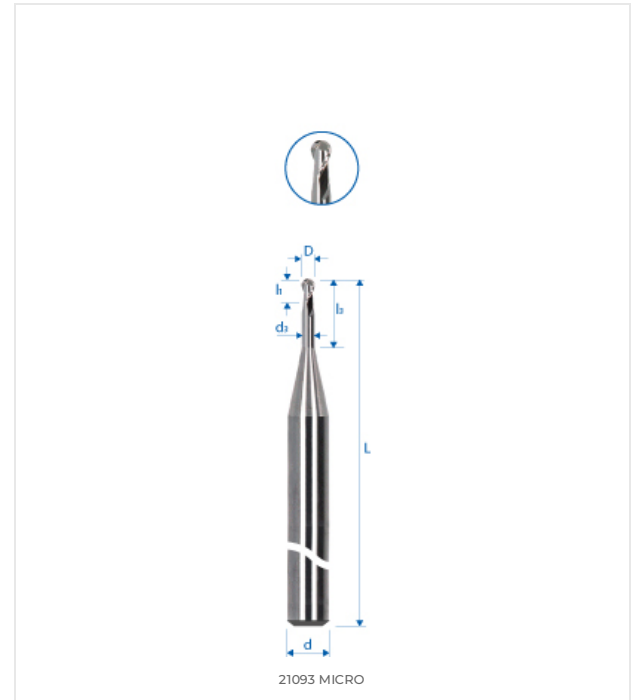

DIMENSIONS

NOMINAL DIMENSIONS	
D (0 / -0.01)	0.5 mm
d (h5)	3 mm
L	38 mm
l1	0.75 mm
l3	2.5 mm
d3	–
R	0.25 mm
e	–
Z	2
Chamfer K	–
w° collision	9.3°



E-SHOP / EZI CUT
eskenazi.ch/eshop/21093A-0.5