

FRAISE-D'ÉBAUCHE-À-PROFIL-PLAT-MD-E2-+-EZI-ALPHA-+L3 · ROUGHING-ENDMILL-FINE-PROFILE-SC-E2-+-EZI-ALPHA · SCHAFT-SCHRUPPFRÄSER-FEIN-PROFIL-HM-E2-+-EZI-ALPHA

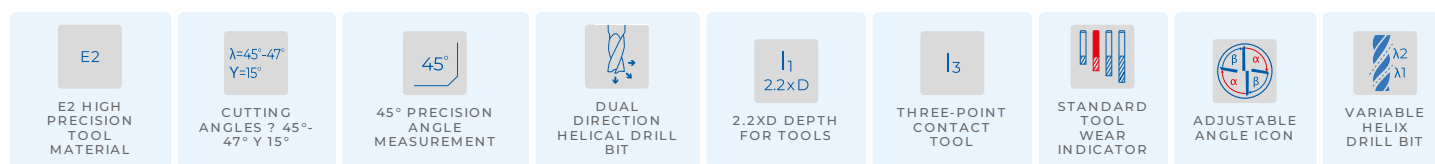

SWISS MADE

21535A-12 Version 21.06.2026



MATERIAL COMPATIBILITY

●●● Excellent (3/3) ●●○ Good (2/3) ●○○ Possible (1/3) ○○○ Not recommended

MATERIAL	SPECIFICATION	GRP	21535A-12
Alloyed and non-alloyed steels <small>Non-alloyed steels</small>	Rm < 450 N/mm ²	1a	●●●
	Rm 450–700 N/mm ²	1b	●●●
	Rm 700–900 N/mm ²	1c	●●●
	Rm > 1200 N/mm ²	1d	●○○
Stainless steels <small>Stainless steels</small>	Rm < 650 N/mm ²	2a	●●●
	Rm 650–950 N/mm ²	2b	●●●
	Rm > 950 N/mm ²	2c	●●●
Hardened steels <small>Hardened steels</small>	44–56 HRC	3a	○○○
	57–67 HRC	3b	○○○
Exotic materials <small>Special alloys</small>	< 32 HRC	4a	●○○
	> 32 HRC	4b	●○○
Graphite <small>Industrial graphite</small>		5	○○○
Cast iron <small>Grey / nodular cast iron</small>	< 32 HRC	6a	●●●
	> 32 HRC	6b	●●●
Titanium <small>Titanium alloys</small>	Rm < 600 N/mm ²	7a	●●●
	600 < Rm N/mm ²	7b	●●●
Nickel alloys <small>Inconel, Hastelloy</small>	Rm < 1000 N/mm ²	8a	●○○
	Rm > 1000 N/mm ²	8b	●○○
Copper, brass, bronze <small>Copper-based</small>	Rm < 850 N/mm ²	9a	●●●
	Rm > 850 N/mm ²	9b	●●●
Aluminum <small>Aluminum alloys</small>	Si < 0.5%	10a	○○○
	0.5% < Si < 5%	10b	○○○
	Si > 5%	10c	○○○
Synthetic materials <small>Engineering plastics</small>	Thermoplastic	11a	○○○
	Thermoset	11b	○○○
Composite materials <small>Reinforced composites</small>	Glass fiber / GFK	12a	○○○
	Carbon fiber / KFK	12b	○○○
Precious metals <small>Gold, platinum, silver</small>	Gold	13a	●●●
	Platinum	13b	●●○

TECHNICAL DRAWING

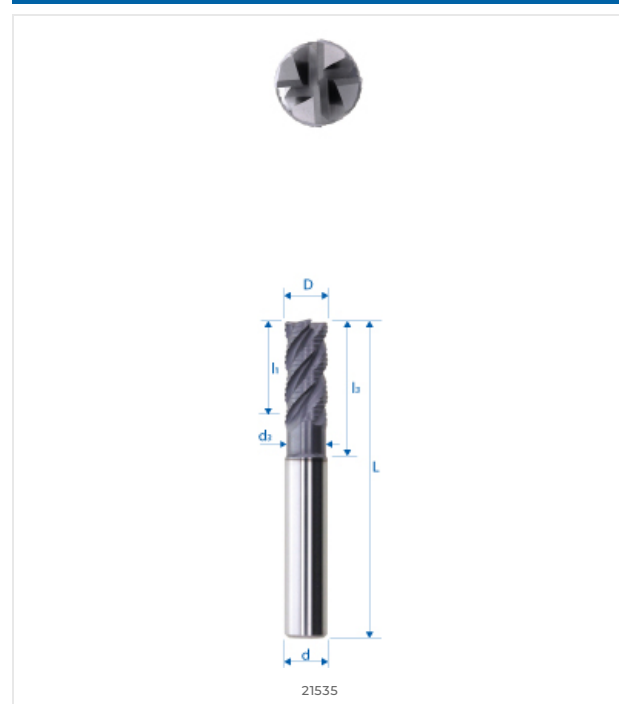

DIMENSIONS

NOMINAL DIMENSIONS	
D (0 / -0.01)	12 mm
d (h5)	12 mm
L	83 mm
l1	26 mm
l3	37 mm
d3	–
R	–
e	–
Z	4
Chamfer K	0.4
w° collision	–



E-SHOP / EZI CUT
eskenazi.ch/eshop/21535A-12