

FRAISE-À-CHANFREINER-45°-MD-E25UF · BEVEL-MILLING-CUTTER-45°-SC-E2 · FASENFRÄSER-45°-HM-E2



21730-1.5

Version 07.05.2026

SWISS MADE

E2

E2 HIGH PRECISION TOOL MATERIAL

$\lambda = 0^\circ$
 $\gamma = 8^\circ$

TOOL ANGLES LAMBDA 0° GAMMA 8°



V-GROOVE CHAMFER TOOL SHAPE



LATERAL CUTTING TWIST DRILL BIT

MATERIAL COMPATIBILITY

●●● Excellent (3/3) ●● Good (2/3) ●○ Possible (1/3) ○○ Not recommended

MATERIAL	SPECIFICATION	GRP	21730-1.5
Alloyed and non-alloyed steels Non-alloyed steels	Rm < 450 N/mm ²	1a	●○
	Rm 450–700 N/mm ²	1b	●○
	Rm 700–900 N/mm ²	1c	●○
	Rm > 1200 N/mm ²	1d	○○
Stainless steels Stainless steels	Rm < 650 N/mm ²	2a	●○
	Rm 650–950 N/mm ²	2b	●○
	Rm > 950 N/mm ²	2c	○○
Hardened steels Hardened steels	44–56 HRC	3a	○○
	57–67 HRC	3b	○○
Exotic materials Special alloys	< 32 HRC	4a	○○
	> 32 HRC	4b	○○
Graphite Industrial graphite		5	●○
Cast iron Grey / nodular cast iron	< 32 HRC	6a	○○
	> 32 HRC	6b	○○
Titanium Titanium alloys	Rm < 600 N/mm ²	7a	●○
	600 < Rm N/mm ²	7b	●○
Nickel alloys Inconel, Hastelloy	Rm < 1000 N/mm ²	8a	○○
	Rm > 1000 N/mm ²	8b	○○
Copper, brass, bronze Copper-based	Rm < 850 N/mm ²	9a	●●●
	Rm > 850 N/mm ²	9b	●●●
Aluminum Aluminum alloys	Si < 0.5%	10a	●●●
	0.5% < Si < 5%	10b	●●●
	Si > 5%	10c	○○
Synthetic materials Engineering plastics	Thermoplastic	11a	●●●
	Thermoset	11b	●●●
Composite materials Reinforced composites	Glass fiber / GFK	12a	●○
	Carbon fiber / KFK	12b	●○
Precious metals Gold, platinum, silver	Gold	13a	●●●
	Platinum	13b	○○

TECHNICAL DRAWING

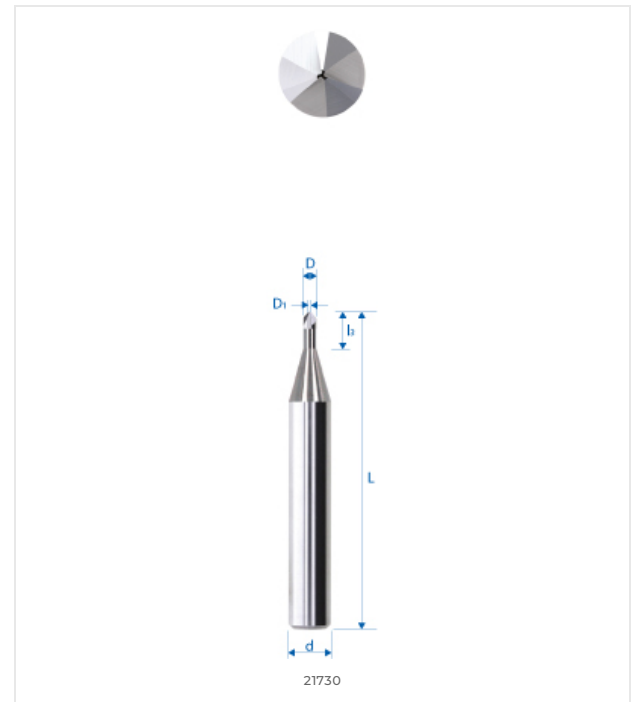

DIMENSIONS

NOMINAL DIMENSIONS	
D (0 / -0.01)	1.5 mm
d (h5)	3 mm
L	38 mm
h	0.6 mm
l3	5 mm
d3	–
R	–
e	0.3 mm
Z	3
Chamfer K	–
w° collision	5.5°



E-SHOP / EZI CUT
eskenazi.ch/eshop/21730-1.5

© 2026 Eskenazi SA — Carouge, Genève
All rights reserved