

FRAISE-A-CHANFREINER-BI-FACE-90°-Z:4-MD-E2-+-EZI- ALPHA-3 · BEVEL-MILLING-CUTTER-BI-FACE-90°-Z:4- CARBIDE-E2-+-EZI-ALPHA-3 · FASENFRAESER-BI-FACE- 90°-Z:4-HM-E2-+-EZI-ALPHA-3



SWISS MADE

21735A-4.7

Version 07.05.2026

E2

E2 HIGH PRECISION TOOL MATERIAL

$\lambda = 0^\circ$
 $\gamma = 8^\circ$

TOOL ANGLES LAMBDA 0° GAMMA 8°



BIFACE MULTI-POINT INTERFACE



LATERAL CUTTING TWIST DRILL BIT

MATERIAL COMPATIBILITY

●●● Excellent (3/3) ●●○ Good (2/3) ●○○ Possible (1/3) ○○○ Not recommended

MATERIAL	SPECIFICATION	GRP	21735A-4.7
Alloyed and non-alloyed steels Non-alloyed steels	Rm < 450 N/mm ²	1a	●●●
	Rm 450–700 N/mm ²	1b	●●●
	Rm 700–900 N/mm ²	1c	●●●
	Rm > 1200 N/mm ²	1d	●●●
Stainless steels Stainless steels	Rm < 650 N/mm ²	2a	●●●
	Rm 650–950 N/mm ²	2b	●●●
	Rm > 950 N/mm ²	2c	●●●
Hardened steels Hardened steels	44–56 HRC	3a	●●○
	57–67 HRC	3b	●○○
Exotic materials Special alloys	< 32 HRC	4a	●●○
	> 32 HRC	4b	●●○
Graphite Industrial graphite		5	●●●
Cast iron Grey / nodular cast iron	< 32 HRC	6a	●●●
	> 32 HRC	6b	●●●
Titanium Titanium alloys	Rm < 600 N/mm ²	7a	●●●
	600 < Rm N/mm ²	7b	●●●
Nickel alloys Inconel, Hastelloy	Rm < 1000 N/mm ²	8a	●●○
	Rm > 1000 N/mm ²	8b	●●○
Copper, brass, bronze Copper-based	Rm < 850 N/mm ²	9a	●●○
	Rm > 850 N/mm ²	9b	●●○
Aluminum Aluminum alloys	Si < 0.5%	10a	●●○
	0.5% < Si < 5%	10b	●●○
	Si > 5%	10c	●●●
Synthetic materials Engineering plastics	Thermoplastic	11a	●○○
	Thermoset	11b	●○○
Composite materials Reinforced composites	Glass fiber / GFK	12a	●●●
	Carbon fiber / KFK	12b	●●●
Precious metals Gold, platinum, silver	Gold	13a	●●○
	Platinum	13b	●●○

TECHNICAL DRAWING

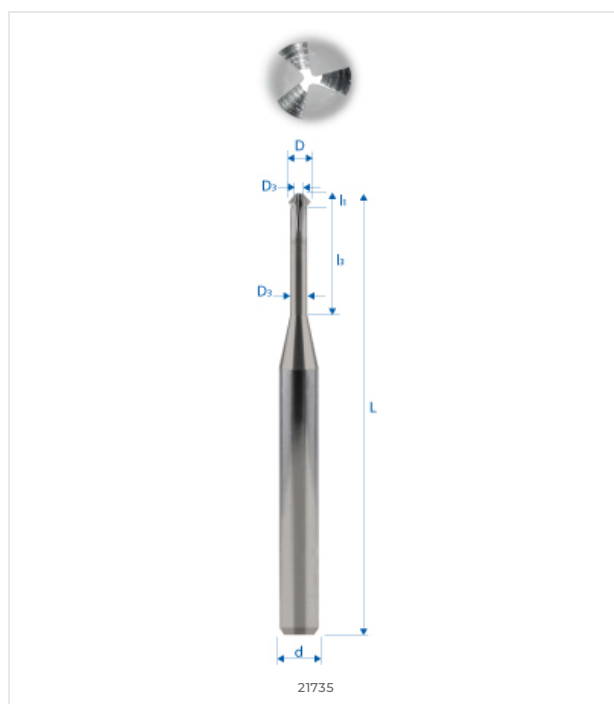

DIMENSIONS

NOMINAL DIMENSIONS

D (0 / -0.01)	4.7 mm
d (h5)	5 mm
L	60 mm
l1	1.6 mm
l3	16 mm
d3	–
R	–
e	–
Z	4
Chamfer K	–
w° collision	0.5°



E-SHOP / EZI CUT
eskenazi.ch/eshop/21735A-4.7