

ALÉSOIR-MACHINE-DENTURE-HÉLICOÏDALE-MD-E2 · MACHINE-REAMER-SPIRAL-FLUTED-SC-E2 · MASCHINEN-REIBAHLEN-SPIRALGENUTET-HM-E2



SWISS MADE

47420-5.05

Version 07.05.2026

E2

E2 HIGH PRECISION TOOL MATERIAL

$\lambda = -5^\circ$
 $\gamma = 5^\circ$

CUTTING ANGLES $\gamma = 5^\circ \text{ ? } 5^\circ$

MATERIAL COMPATIBILITY

●●● Excellent (3/3) ●●○ Good (2/3) ●○○ Possible (1/3) ○○○ Not recommended

MATERIAL	SPECIFICATION	GRP	47420-5.05
Alloyed and non-alloyed steels Non-alloyed steels	$R_m < 450 \text{ N/mm}^2$	1a	●●○
	$R_m 450\text{--}700 \text{ N/mm}^2$	1b	●●○
	$R_m 700\text{--}900 \text{ N/mm}^2$	1c	●●○
	$R_m > 1200 \text{ N/mm}^2$	1d	●●○
Stainless steels Stainless steels	$R_m < 650 \text{ N/mm}^2$	2a	●●○
	$R_m 650\text{--}950 \text{ N/mm}^2$	2b	●●○
	$R_m > 950 \text{ N/mm}^2$	2c	●●○
Hardened steels Hardened steels	44–56 HRC	3a	●○○
	57–67 HRC	3b	○○○
Exotic materials Special alloys	< 32 HRC	4a	●●○
	> 32 HRC	4b	●●○
Graphite Industrial graphite		5	●●○
Cast iron Grey / nodular cast iron	< 32 HRC	6a	●●○
	> 32 HRC	6b	●●○
Titanium Titanium alloys	$R_m < 600 \text{ N/mm}^2$	7a	●●○
	$600 < R_m \text{ N/mm}^2$	7b	●●○
Nickel alloys Inconel, Hastelloy	$R_m < 1000 \text{ N/mm}^2$	8a	●○○
	$R_m > 1000 \text{ N/mm}^2$	8b	●○○
Copper, brass, bronze Copper-based	$R_m < 850 \text{ N/mm}^2$	9a	●●●
	$R_m > 850 \text{ N/mm}^2$	9b	●●●
Aluminum Aluminum alloys	$Si < 0.5\%$	10a	●●●
	$0.5\% < Si < 5\%$	10b	●●●
	$Si > 5\%$	10c	●●○
Synthetic materials Engineering plastics	Thermoplastic	11a	●●●
	Thermoset	11b	●●●
Composite materials Reinforced composites	Glass fiber / GFK	12a	●●○
	Carbon fiber / KFK	12b	●●○
Precious metals Gold, platinum, silver	Gold	13a	●●●
	Platinum	13b	●○○

TECHNICAL DRAWING

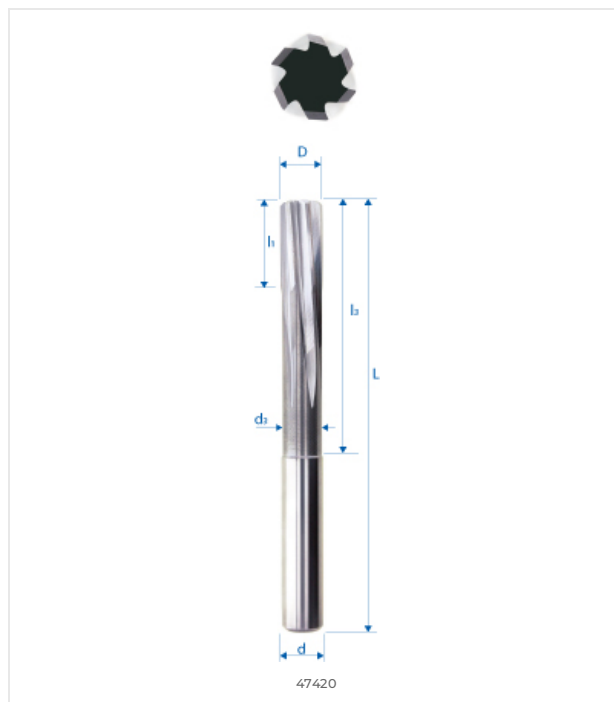

DIMENSIONS

NOMINAL DIMENSIONS

D (0 / -0.01)	5.05 mm
d (h5)	5.05 mm
L	86 mm
l1	23 mm
l3	52 mm
d3	–
R	–
e	–
Z	4
Chamfer K	0.5
w° collision	–



E-SHOP / EZI CUT
eskenazi.ch/eshop/47420-5.05

© 2026 Eskenazi SA — Carouge, Genève
All rights reserved