

# ALÉSOIR-MACHINE-DENTURE-HÉLICOÏDALE-MD-E2 · MACHINE-REAMER-SPIRAL-FLUTED-SC-E2 · MASCHINEN-REIBAHLEN-SPIRALGENUTET-HM-E2



SWISS MADE

47420-6.05

Version 07.05.2026

E2

E2 HIGH PRECISION TOOL MATERIAL

$\lambda = -5^\circ$   
 $\gamma = 5^\circ$

CUTTING ANGLES  $\gamma = 5^\circ \text{ ? } 5^\circ$

## MATERIAL COMPATIBILITY

●●● Excellent (3/3) ●●○ Good (2/3) ●○○ Possible (1/3) ○○○ Not recommended

MATERIAL	SPECIFICATION	GRP	47420-6.05
<b>Alloyed and non-alloyed steels</b> Non-alloyed steels	$R_m < 450 \text{ N/mm}^2$	1a	●●○
	$R_m 450\text{--}700 \text{ N/mm}^2$	1b	●●○
	$R_m 700\text{--}900 \text{ N/mm}^2$	1c	●●○
	$R_m > 1200 \text{ N/mm}^2$	1d	●●○
<b>Stainless steels</b> Stainless steels	$R_m < 650 \text{ N/mm}^2$	2a	●●○
	$R_m 650\text{--}950 \text{ N/mm}^2$	2b	●●○
	$R_m > 950 \text{ N/mm}^2$	2c	●●○
<b>Hardened steels</b> Hardened steels	44–56 HRC	3a	●○○
	57–67 HRC	3b	○○○
<b>Exotic materials</b> Special alloys	< 32 HRC	4a	●●○
	> 32 HRC	4b	●●○
<b>Graphite</b> Industrial graphite		5	●●○
<b>Cast iron</b> Grey / nodular cast iron	< 32 HRC	6a	●●○
	> 32 HRC	6b	●●○
<b>Titanium</b> Titanium alloys	$R_m < 600 \text{ N/mm}^2$	7a	●●○
	$600 < R_m \text{ N/mm}^2$	7b	●●○
<b>Nickel alloys</b> Inconel, Hastelloy	$R_m < 1000 \text{ N/mm}^2$	8a	●○○
	$R_m > 1000 \text{ N/mm}^2$	8b	●○○
<b>Copper, brass, bronze</b> Copper-based	$R_m < 850 \text{ N/mm}^2$	9a	●●●
	$R_m > 850 \text{ N/mm}^2$	9b	●●●
<b>Aluminum</b> Aluminum alloys	$Si < 0.5\%$	10a	●●●
	$0.5\% < Si < 5\%$	10b	●●●
	$Si > 5\%$	10c	●●○
<b>Synthetic materials</b> Engineering plastics	Thermoplastic	11a	●●●
	Thermoset	11b	●●●
<b>Composite materials</b> Reinforced composites	Glass fiber / GFK	12a	●●○
	Carbon fiber / KFK	12b	●●○
<b>Precious metals</b> Gold, platinum, silver	Gold	13a	●●●
	Platinum	13b	●○○

## TECHNICAL DRAWING

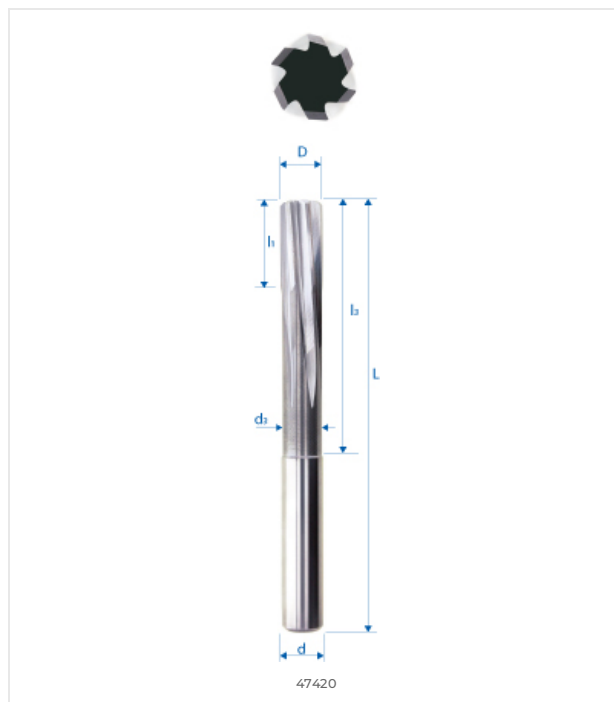

## DIMENSIONS

### NOMINAL DIMENSIONS

D (0 / -0.01)	6.05 mm
d (h5)	6.05 mm
L	93 mm
l1	23 mm
l3	57 mm
d3	–
R	–
e	–
Z	6
Chamfer K	0.6
w° collision	–



E-SHOP / EZI CUT  
eskenazi.ch/eshop/47420-6.05

© 2026 Eskenazi SA — Carouge, Genève  
All rights reserved