

ALÉSOIR-MD-E2S-+-TROU-D'ARROSAGE · -REAMER-SC-E2S-+-INTERNAL-COOLING · REIBAHLEN-HM-E2S-+-COOLING



SWISS MADE

47480S-5.04

Version 07.05.2026

E2

E2 HIGH PRECISION TOOL MATERIAL

$\lambda = -5^\circ$
 $\gamma = 5^\circ$

CUTTING ANGLES ? -5° ? 5°



CENTRAL COOLANT DRILL BIT

MATERIAL COMPATIBILITY

●●● Excellent (3/3) ●●○ Good (2/3) ●○○ Possible (1/3) ○○○ Not recommended

MATERIAL	SPECIFICATION	GRP	47480S-5.04
Alloyed and non-alloyed steels Non-alloyed steels	Rm < 450 N/mm ²	1a	●●●
	Rm 450–700 N/mm ²	1b	●●●
	Rm 700–900 N/mm ²	1c	●●●
	Rm > 1200 N/mm ²	1d	●●●
Stainless steels Stainless steels	Rm < 650 N/mm ²	2a	●●●
	Rm 650–950 N/mm ²	2b	●●●
	Rm > 950 N/mm ²	2c	●●●
Hardened steels Hardened steels	44–56 HRC	3a	●●○
	57–67 HRC	3b	●●○
Exotic materials Special alloys	< 32 HRC	4a	●●●
	> 32 HRC	4b	●●●
Graphite Industrial graphite		5	●●●
Cast iron Grey / nodular cast iron	< 32 HRC	6a	●●●
	> 32 HRC	6b	●●●
Titanium Titanium alloys	Rm < 600 N/mm ²	7a	●●●
	600 < Rm N/mm ²	7b	●●●
Nickel alloys Inconel, Hastelloy	Rm < 1000 N/mm ²	8a	●●●
	Rm > 1000 N/mm ²	8b	●●●
Copper, brass, bronze Copper-based	Rm < 850 N/mm ²	9a	●●●
	Rm > 850 N/mm ²	9b	●●●
Aluminum Aluminum alloys	Si < 0.5%	10a	●●●
	0.5% < Si < 5%	10b	●●●
	Si > 5%	10c	●●●
Synthetic materials Engineering plastics	Thermoplastic	11a	●●●
	Thermoset	11b	●●●
Composite materials Reinforced composites	Glass fiber / GFK	12a	●●●
	Carbon fiber / KFK	12b	●●●
Precious metals Gold, platinum, silver	Gold	13a	●●●
	Platinum	13b	●●○

TECHNICAL DRAWING

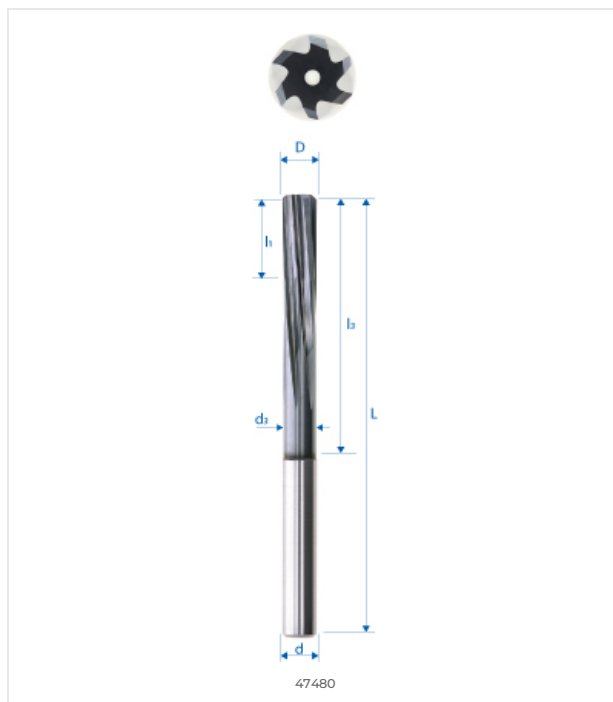

DIMENSIONS

NOMINAL DIMENSIONS	
D (0 / -0.01)	5.04 mm
d (h5)	5 mm
L	100 mm
l1	15 mm
l3	50 mm
d3	–
R	–
e	–
Z	4
Chamfer K	0.5
w° collision	–



E-SHOP / EZI CUT
eskenazi.ch/eshop/47480S-5.04

© 2026 Eskenazi SA — Carouge, Genève
All rights reserved