

FRAISE-DE-FINITION-MD-E2+-EZI-ALPHA · FINISHING- ENDMILL-SC-E2+-EZI-ALPHA · SCHLICHTFRÄSER-HM-E2- +-EZI-ALPHA



SWISS MADE

21144A-14

Version du 07.05.2026

E2

OUTIL E2 MATÉRIAU
HAUTE PRÉCISION

$\lambda = 45^\circ$
 $\gamma = 8^\circ$

ANGLES DE COUPE $\gamma 45^\circ$
 $\gamma 8^\circ$

$\phi \leq 6$ $\phi > 6$
90° 45°

CHANFREIN $\phi < 6$ $\phi > 6$
90° 45°



FORET HÉLICOÏDAL À
DOUBLE SENS

$\frac{1}{3}$
8xD

OUTIL DE COUPE 8XD
LONGUEUR L3



BARRES DE MESURE
LONGUEUR OUTILS

COMPATIBILITÉ MATIÈRE

●●● Excellent (3/3) ●●○ Bon (2/3) ●○○ Possible (1/3) ○○○ Non recommandé

MATIÈRE	SPÉCIFICATION	GRP	21144A-14
Aciers alliés et non alliés Aciers non alliés	Rm < 450 N/mm ²	1a	●●●
	Rm 450-700 N/mm ²	1b	●●●
	Rm 700-900 N/mm ²	1c	●●●
	Rm > 1200 N/mm ²	1d	●●●
Aciers Inox Aciers inoxydables	Rm < 650 N/mm ²	2a	●●●
	Rm 650-950 N/mm ²	2b	●●●
	Rm > 950 N/mm ²	2c	●●●
Aciers trempés Aciers durcis	44-56 HRC	3a	●●○
	57-67 HRC	3b	●○○
Matériaux exotiques Alliages spéciaux	< 32 HRC	4a	●●●
	> 32 HRC	4b	●●○
Graphite Graphite industriel		5	●●○
Fontes Fonte grise / nodulaire	< 32 HRC	6a	●●●
	> 32 HRC	6b	●●●
Titane Alliages titane	Rm < 600 N/mm ²	7a	●●●
	600 < Rm N/mm ²	7b	●●●
Alliages Nickel Inconel, Hastelloy	Rm < 1000 N/mm ²	8a	●●○
	Rm > 1000 N/mm ²	8b	●●○
Cuivre, laiton, bronze Cuivreux	Rm < 850 N/mm ²	9a	●○○
	Rm > 850 N/mm ²	9b	●○○
Aluminium Alliages aluminium	Si < 0.5%	10a	●○○
	0.5% < Si < 5%	10b	●○○
	Si > 5%	10c	●●○
Matières synthétiques Plastiques techniques	Thermoplastique	11a	●○○
	Thermodurcissable	11b	●○○
Matières composites Composites renforcés	Fibre de verre / GFK	12a	●○○
	Fibre de carbone / KFK	12b	●○○
Métaux précieux Or, platine, argent	Or	13a	●○○
	Platine	13b	●○○

DESSIN TECHNIQUE

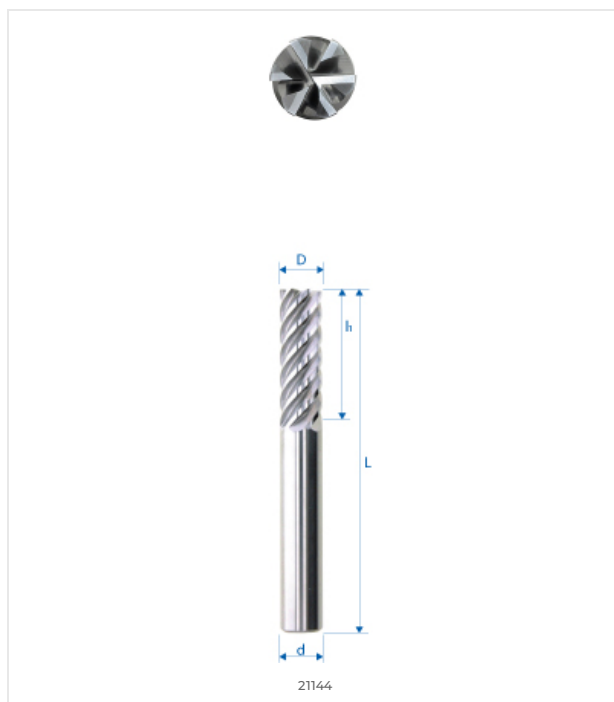

DIMENSIONS

DIMENSIONS NOMINALES	
D (0 / -0.01)	14 mm
d (h5)	14 mm
L	83 mm
l1	33 mm
l3	-
d3	-
R	-
e	-
Z	8
Chanfrein K	0.1
w° collision	-



E-SHOP / EZI CUT
eskenazi.ch/eshop/21144A-14