

FRAISE-HÉMISPHERIQUE Z4 · BALL-NOSE-ENDMILL Z4 · HALBRUND-FRÄSER Z4



21433A-6

Version du 07.05.2026

SWISS MADE



COMPATIBILITÉ MATIÈRE

●●● Excellent (3/3) ●●○ Bon (2/3) ●○○ Possible (1/3) ○○○ Non recommandé

MATIÈRE	SPÉCIFICATION	GRP	21433A-6
Aciers alliés et non alliés <small>Aciers non alliés</small>	Rm < 450 N/mm ²	1a	○○○
	Rm 450–700 N/mm ²	1b	○○○
	Rm 700–900 N/mm ²	1c	●○○
	Rm > 1200 N/mm ²	1d	●●●
Aciers Inox <small>Aciers inoxydables</small>	Rm < 650 N/mm ²	2a	●○○
	Rm 650–950 N/mm ²	2b	●○○
	Rm > 950 N/mm ²	2c	●●○
Aciers trempés <small>Aciers durcis</small>	44–56 HRC	3a	●●●
	57–67 HRC	3b	●●●
Matériaux exotiques <small>Alliages spéciaux</small>	< 32 HRC	4a	●●●
	> 32 HRC	4b	●●●
Graphite <small>Graphite industriel</small>		5	○○○
Fontes <small>Fonte grise / nodulaire</small>	< 32 HRC	6a	●○○
	> 32 HRC	6b	●○○
Titane <small>Alliages titane</small>	Rm < 600 N/mm ²	7a	●○○
	600 < Rm N/mm ²	7b	●○○
Alliages Nickel <small>Inconel, Hastelloy</small>	Rm < 1000 N/mm ²	8a	●●●
	Rm > 1000 N/mm ²	8b	●●●
Cuivre, laiton, bronze <small>Cuivreux</small>	Rm < 850 N/mm ²	9a	○○○
	Rm > 850 N/mm ²	9b	○○○
Aluminium <small>Alliages aluminium</small>	Si < 0.5%	10a	○○○
	0.5% < Si < 5%	10b	○○○
	Si > 5%	10c	○○○
Matières synthétiques <small>Plastiques techniques</small>	Thermoplastique	11a	○○○
	Thermodurcissable	11b	○○○
Matières composites <small>Composites renforcés</small>	Fibre de verre / GFK	12a	○○○
	Fibre de carbone / KFK	12b	○○○
Métaux précieux <small>Or, platine, argent</small>	Or	13a	○○○
	Platine	13b	○○○

DESSIN TECHNIQUE

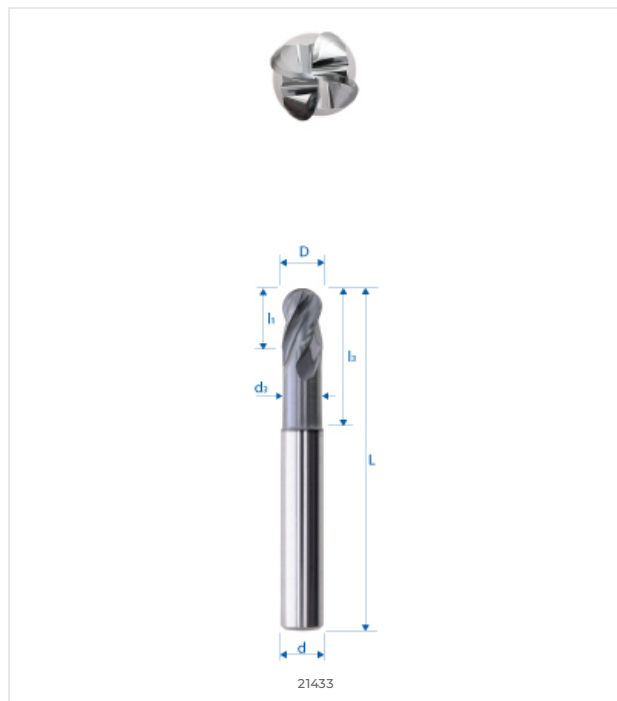

DIMENSIONS

DIMENSIONS NOMINALES	
D (0 / -0.01)	6 mm
d (h5)	6 mm
L	57 mm
l1	9 mm
l3	20 mm
d3	–
R	3 mm
e	–
Z	4
Chanfrein K	–
w° collision	–



E-SHOP / EZI CUT
eskenazi.ch/eshop/21433A-6