

FRAISE-D'ÉBAUCHE-À-PROFIL-PLAT-MD-E2+-EZI- ALPHA+L3 · ROUGHING-ENDMILL-FINE-PROFILE-SC-E2- +-EZI-ALPHA · SCHAFT-SCHRUPPFRÄSER-FEIN-PROFIL- HM-E25UF+-EZI-ALPHA



SWISS MADE

21525A-3-6

Version du 07.05.2026

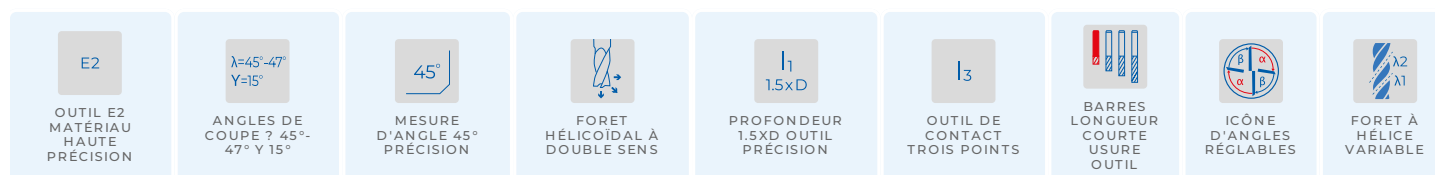

COMPATIBILITÉ MATIÈRE

●●● Excellent (3/3) ●● Bon (2/3) ●○ Possible (1/3) ○○ Non recommandé

MATIÈRE	SPÉCIFICATION	GRP	21525A-3-6
Aciers alliés et non alliés <i>Aciers non alliés</i>	Rm < 450 N/mm ²	1a	●●●
	Rm 450–700 N/mm ²	1b	●●●
	Rm 700–900 N/mm ²	1c	●●●
	Rm > 1200 N/mm ²	1d	●○
Aciers Inox <i>Aciers inoxydables</i>	Rm < 650 N/mm ²	2a	●●●
	Rm 650–950 N/mm ²	2b	●●●
	Rm > 950 N/mm ²	2c	●●●
Aciers trempés <i>Aciers durcis</i>	44–56 HRC	3a	○○
	57–67 HRC	3b	○○
Matériaux exotiques <i>Alliages spéciaux</i>	< 32 HRC	4a	●○
	> 32 HRC	4b	●○
Graphite <i>Graphite industriel</i>		5	○○
Fontes <i>Fonte grise / nodulaire</i>	< 32 HRC	6a	●●●
	> 32 HRC	6b	●●●
Titane <i>Alliages titane</i>	Rm < 600 N/mm ²	7a	●●●
	600 < Rm N/mm ²	7b	●●●
Alliages Nickel <i>Inconel, Hastelloy</i>	Rm < 1000 N/mm ²	8a	●○
	Rm > 1000 N/mm ²	8b	●○
Cuivre, laiton, bronze <i>Cuivreux</i>	Rm < 850 N/mm ²	9a	●●●
	Rm > 850 N/mm ²	9b	●●●
Aluminium <i>Alliages aluminium</i>	Si < 0.5%	10a	○○
	0.5% < Si < 5%	10b	○○
	Si > 5%	10c	○○
Matières synthétiques <i>Plastiques techniques</i>	Thermoplastique	11a	○○
	Thermodurcissable	11b	○○
Matières composites <i>Composites renforcés</i>	Fibre de verre / GFK	12a	○○
	Fibre de carbone / KFK	12b	○○
Métaux précieux <i>Or, platine, argent</i>	Or	13a	●●●
	Platine	13b	●●○

DESSIN TECHNIQUE

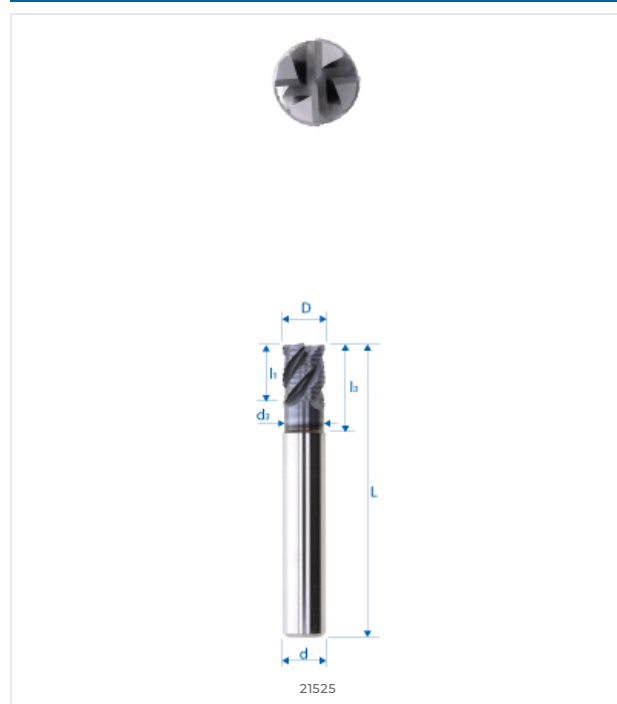

DIMENSIONS

DIMENSIONS NOMINALES	
D (0 / -0.01)	3 mm
d (h5)	6 mm
L	50 mm
l1	4 mm
l3	9 mm
d3	–
R	–
e	–
Z	3
Chanfrein K	0.2
w° collision	5.8°



E-SHOP / EZI CUT
eskenazi.ch/eshop/21525A-3-6