

# FRAISE-A-CHANFREINER-BI-FACE-90°-Z:3-MD-E25-UF · BEVEL-MILLING-CUTTER-BI-FACE-90°-Z:3-CARBIDE-E25-UF · FASENFRAESER-BI-FACE-90°-Z:3-HM-E25-UF



SWISS MADE

21735-0.65

Version du 05.05.2026

E2

OUTIL E2 MATÉRIAU HAUTE PRÉCISION

$\lambda = 0^\circ$   
 $\gamma = 8^\circ$

ANGLES OUTILS LAMBDA 0° GAMMA 8°



INTERFACE MULTI-POINTS BIFACE



FORET HÉLICOÏDAL COUPE LATÉRALE

## COMPATIBILITÉ MATIÈRE

●●● Excellent (3/3) ●●○ Bon (2/3) ●○○ Possible (1/3) ○○○ Non recommandé

MATIÈRE	SPÉCIFICATION	GRP	21735-0.65
<b>Aciers alliés et non alliés</b> <small>Aciers non alliés</small>	Rm < 450 N/mm <sup>2</sup>	1a	●○○
	Rm 450–700 N/mm <sup>2</sup>	1b	●○○
	Rm 700–900 N/mm <sup>2</sup>	1c	●○○
	Rm > 1200 N/mm <sup>2</sup>	1d	○○○
<b>Aciers Inox</b> <small>Aciers inoxydables</small>	Rm < 650 N/mm <sup>2</sup>	2a	●○○
	Rm 650–950 N/mm <sup>2</sup>	2b	●○○
	Rm > 950 N/mm <sup>2</sup>	2c	○○○
<b>Aciers trempés</b> <small>Aciers durcis</small>	44–56 HRC	3a	○○○
	57–67 HRC	3b	○○○
<b>Matériaux exotiques</b> <small>Alliages spéciaux</small>	< 32 HRC	4a	○○○
	> 32 HRC	4b	○○○
<b>Graphite</b> <small>Graphite industriel</small>		5	●○○
<b>Fontes</b> <small>Fonte grise / nodulaire</small>	< 32 HRC	6a	○○○
	> 32 HRC	6b	○○○
<b>Titane</b> <small>Alliages titane</small>	Rm < 600 N/mm <sup>2</sup>	7a	●○○
	600 < Rm N/mm <sup>2</sup>	7b	●○○
<b>Alliages Nickel</b> <small>Inconel, Hastelloy</small>	Rm < 1000 N/mm <sup>2</sup>	8a	○○○
	Rm > 1000 N/mm <sup>2</sup>	8b	○○○
<b>Cuivre, laiton, bronze</b> <small>Cuivreux</small>	Rm < 850 N/mm <sup>2</sup>	9a	●●●
	Rm > 850 N/mm <sup>2</sup>	9b	●●●
<b>Aluminium</b> <small>Alliages aluminium</small>	Si < 0.5%	10a	●●●
	0.5% < Si < 5%	10b	●●●
	Si > 5%	10c	○○○
<b>Matières synthétiques</b> <small>Plastiques techniques</small>	Thermoplastique	11a	●●●
	Thermodurcissable	11b	●●●
<b>Matières composites</b> <small>Composites renforcés</small>	Fibre de verre / GFK	12a	●○○
	Fibre de carbone / KFK	12b	●○○
<b>Métaux précieux</b> <small>Or, platine, argent</small>	Or	13a	●●●
	Platine	13b	○○○

## DESSIN TECHNIQUE

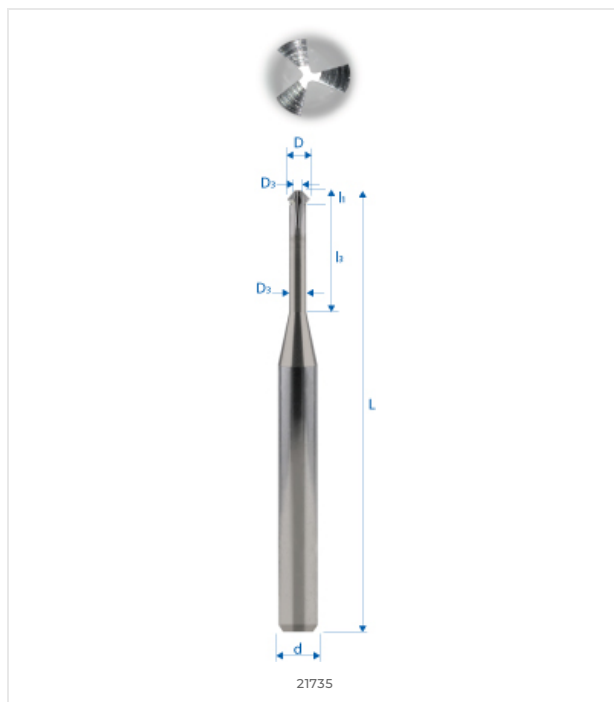

## DIMENSIONS

DIMENSIONS NOMINALES	
D (0 / -0.01)	0.65 mm
d (h5)	3 mm
L	38 mm
l1	0.26 mm
l3	1.3 mm
d3	–
R	–
e	–
Z	3
Chanfrein K	–
w° collision	10.7°



E-SHOP / EZI CUT  
eskenazi.ch/eshop/21735-0.65

© 2026 Eskenazi SA — Carouge, Genève  
Tous droits réservés