

FRAISE-A-CHANFREINER-BI-FACE-90°-Z:3-MD-E25-UF · BEVEL-MILLING-CUTTER-BI-FACE-90°-Z:3-CARBIDE-E25- UF · FASENFRAESER-BI-FACE-90°-Z:3-HM-E25-UF



SWISS MADE

21735-1.5

Version du 05.05.2026

E2

OUTIL E2 MATÉRIAU HAUTE PRÉCISION

$\lambda=0^\circ$
 $\gamma=8^\circ$

ANGLES OUTILS LAMBDA 0° GAMMA 8°



INTERFACE MULTI-POINTS BIFACE



FORET HÉLICOÏDAL COUPE LATÉRALE

COMPATIBILITÉ MATIÈRE

●●● Excellent (3/3) ●● Bon (2/3) ●○ Possible (1/3) ○○ Non recommandé

MATIÈRE	SPÉCIFICATION	GRP	21735-1.5
Aciers alliés et non alliés <small>Aciers non alliés</small>	Rm < 450 N/mm ²	1a	●○
	Rm 450–700 N/mm ²	1b	●○
	Rm 700–900 N/mm ²	1c	●○
	Rm > 1200 N/mm ²	1d	○○
Aciers Inox <small>Aciers inoxydables</small>	Rm < 650 N/mm ²	2a	●○
	Rm 650–950 N/mm ²	2b	●○
	Rm > 950 N/mm ²	2c	○○
Aciers trempés <small>Aciers durcis</small>	44–56 HRC	3a	○○
	57–67 HRC	3b	○○
Matériaux exotiques <small>Alliages spéciaux</small>	< 32 HRC	4a	○○
	> 32 HRC	4b	○○
Graphite <small>Graphite industriel</small>		5	●○
Fontes <small>Fonte grise / nodulaire</small>	< 32 HRC	6a	○○
	> 32 HRC	6b	○○
Titane <small>Alliages titane</small>	Rm < 600 N/mm ²	7a	●○
	600 < Rm N/mm ²	7b	●○
Alliages Nickel <small>Inconel, Hastelloy</small>	Rm < 1000 N/mm ²	8a	○○
	Rm > 1000 N/mm ²	8b	○○
Cuivre, laiton, bronze <small>Cuivreux</small>	Rm < 850 N/mm ²	9a	●●●
	Rm > 850 N/mm ²	9b	●●●
Aluminium <small>Alliages aluminium</small>	Si < 0.5%	10a	●●●
	0.5% < Si < 5%	10b	●●●
	Si > 5%	10c	○○
Matières synthétiques <small>Plastiques techniques</small>	Thermoplastique	11a	●●●
	Thermodurcissable	11b	●●●
Matières composites <small>Composites renforcés</small>	Fibre de verre / GFK	12a	●○
	Fibre de carbone / KFK	12b	●○
Métaux précieux <small>Or, platine, argent</small>	Or	13a	●●●
	Platine	13b	○○

DESSIN TECHNIQUE

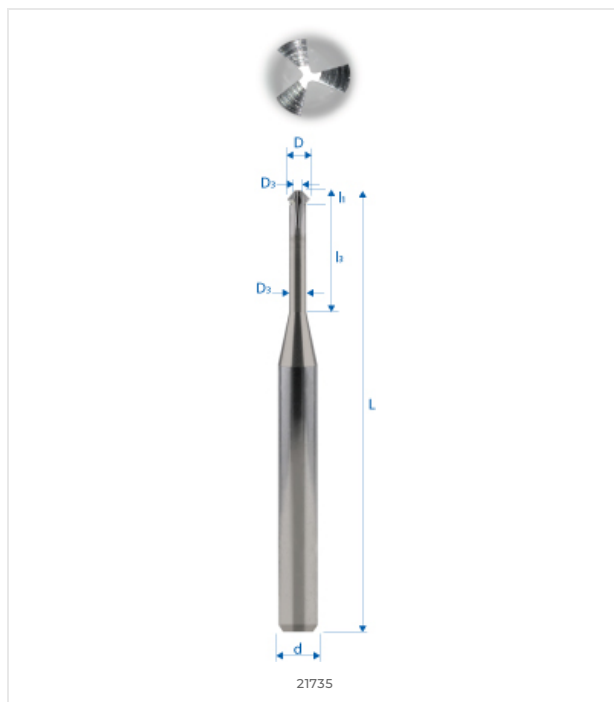

DIMENSIONS

DIMENSIONS NOMINALES	
D (0 / -0.01)	1.5 mm
d (h5)	3 mm
L	38 mm
l1	0.4 mm
l3	4.5 mm
d3	–
R	–
e	–
Z	3
Chanfrein K	–
w° collision	5.8°



E-SHOP / EZI CUT
eskenazi.ch/eshop/21735-1.5

© 2026 Eskenazi SA — Carouge, Genève
Tous droits réservés