

ALÉSOIR-MD-E2S-+-TROU-D'ARROSAGE · -REAMER-SC-E2S-+-INTERNAL-COOLING · REIBAHLEN-HM-E2S-+-COOLING



SWISS MADE

47480S-4.04

Version du 07.05.2026

E2

OUTIL E2 MATÉRIAU HAUTE PRÉCISION

$\lambda = -5^\circ$
 $\gamma = 5^\circ$

ANGLES DE COUPE ? -5° ? 5°



FORET À ARROSAGE CENTRAL

COMPATIBILITÉ MATIÈRE

●●● Excellent (3/3) ●●○ Bon (2/3) ●○○ Possible (1/3) ○○○ Non recommandé

MATIÈRE	SPÉCIFICATION	GRP	47480S-4.04
Aciers alliés et non alliés <small>Aciers non alliés</small>	Rm < 450 N/mm ²	1a	●●●
	Rm 450–700 N/mm ²	1b	●●●
	Rm 700–900 N/mm ²	1c	●●●
	Rm > 1200 N/mm ²	1d	●●●
Aciers Inox <small>Aciers inoxydables</small>	Rm < 650 N/mm ²	2a	●●●
	Rm 650–950 N/mm ²	2b	●●●
	Rm > 950 N/mm ²	2c	●●●
Aciers trempés <small>Aciers durcis</small>	44–56 HRC	3a	●●○
	57–67 HRC	3b	●●○
Matériaux exotiques <small>Alliages spéciaux</small>	< 32 HRC	4a	●●●
	> 32 HRC	4b	●●●
Graphite <small>Graphite industriel</small>		5	●●●
Fontes <small>Fonte grise / nodulaire</small>	< 32 HRC	6a	●●●
	> 32 HRC	6b	●●●
Titane <small>Alliages titane</small>	Rm < 600 N/mm ²	7a	●●●
	600 < Rm N/mm ²	7b	●●●
Alliages Nickel <small>Inconel, Hastelloy</small>	Rm < 1000 N/mm ²	8a	●●●
	Rm > 1000 N/mm ²	8b	●●●
Cuivre, laiton, bronze <small>Cuivreux</small>	Rm < 850 N/mm ²	9a	●●●
	Rm > 850 N/mm ²	9b	●●●
Aluminium <small>Alliages aluminium</small>	Si < 0.5%	10a	●●●
	0.5% < Si < 5%	10b	●●●
	Si > 5%	10c	●●●
Matières synthétiques <small>Plastiques techniques</small>	Thermoplastique	11a	●●●
	Therm durcissable	11b	●●●
Matières composites <small>Composites renforcés</small>	Fibre de verre / GFK	12a	●●●
	Fibre de carbone / KFK	12b	●●●
Métaux précieux <small>Or, platine, argent</small>	Or	13a	●●●
	Platine	13b	●●○

DESSIN TECHNIQUE

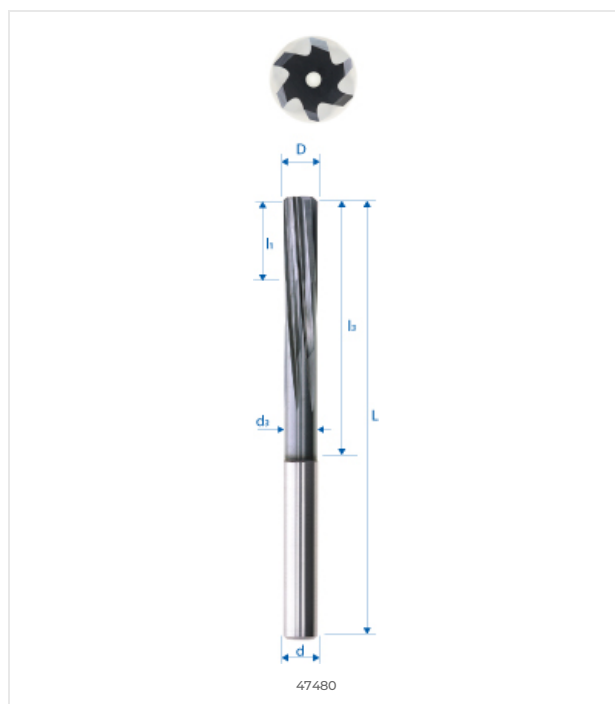

DIMENSIONS

DIMENSIONS NOMINALES

D (0 / -0.01)	4.04 mm
d (h5)	4 mm
L	80 mm
l1	15 mm
l3	40 mm
d3	–
R	–
e	–
Z	4
Chanfrein K	0.4
w° collision	–



E-SHOP / EZI CUT
eskenazi.ch/eshop/47480S-4.04

© 2026 Eskenazi SA — Carouge, Genève
Tous droits réservés